

ACS-5161

60 Watt PC/104 Power Supply, Galvanically Isolated
Vin = 18 ~ 36VDC, Vout= +5, +12 VDC

Rev. 1.0 - November 2008 - ETH_ACS-5161_USM1.0

Disclaimer

The information in this manual has been carefully checked and is believed to be accurate. Eurotech assumes no responsibility for any infringements of patents or other rights of third parties, which may result from its use.

Eurotech assumes no responsibility for any inaccuracies that may be contained in this document. Eurotech makes no commitment to update or keep current the information contained in this manual.

Eurotech reserves the right to make improvements to this document and/or product at any time and without notice.

Warranty

This product is supplied with a limited warranty. The product warranty covers failure of any Eurotech manufactured product caused by manufacturing defects. Eurotech will make all reasonable effort to repair the product or replace it with an equivalent alternative. Eurotech reserves the right to replace the returned product with an alternative variant or an equivalent fit, form and functional product. Delivery charges will apply to all returned products.

Trademarks

All trademarks, both marked and not marked, appearing in this document are the property of their respective owners.

WEEE

The information below is issued in compliance with the regulations as set out in the 2002/96/CE directive, subsequently superseded by 2003/108/CE. It refers electrical and electronic equipment and the waste management of such products.

When disposing of a device, including all of its components, subassemblies and materials that are an integral part of the product, you should consider the WEEE directive.



This symbol has been attached to the equipment or, if this has not been possible, on the packaging, instruction literature and/or the guarantee sheet. By using this symbol, it states that the device has been marketed after August 13th 2005, and implies that you must separate all of its components when possible, and dispose of them in accordance with local waste disposal legislations.

- Because of the substances present in the equipment, improper use or disposal of the refuse can cause damage to human health and to the environment.
- With reference to WEEE, it is compulsory not dispose of the equipment with normal urban refuse, arrangements should be instigated for separate collection and disposal.
- Contact your local waste collection body for more detailed recycling information.
- In case of illicit disposal, sanctions will be levied on transgressors.

RoHS

This device, including all its components, subassemblies and the consumable materials that are an integral part of the product, has been manufactured in compliance with the European directive 2002/95/EC known as the RoHS directive (Restrictions on the use of certain Hazardous Substances). This directive targets the reduction of certain hazardous substances previously used in electrical and electronic equipment (EEE).

© 2008 Eurotech Spa

Eurotech S.p.A.

A member of the Eurotech Group

Via Fratelli Solari, 3/a

33020 - AMARO (UD)

ITALY

Introduction

Conventions used within this Manual

The following conventions are used throughout this manual.

The “Mode” of the register:

Symbol / Text	Definition
RW	Readable and Writable register
RO	Read only register
W	Meaning of the register when written
R	Meaning of the register when read

Hexadecimal numbering:

Hexadecimal numbers are indicated with an “h” suffix (for example: 11Ch)

Symbols and Text used in Pin-out tables:

Symbol / Text	Definition
◀	Input
▶	Output
◀▶	Bi-Directional
—	Passive
Module specific	Dependent on module installed
NC	Not Connected
Reserved	Use reserved to Eurotech, must remain unconnected
#	Active low signal

Warnings and Important Notices:

Within this manual you will find the following tables, please ensure that you read and understand these as they are intended to highlight potential risks or precautions that should be taken.



Warnings:

Information to alert you to potential hazards:
Potential personal injury or damage to a system, device, or program.



Information and Notes:

Indicates important features or instructions that should be observed

Technical Assistance

If you have any technical questions or if you cannot isolate a problem with your device, please e-mail the Eurotech Technical Support Team: email: techsupp@eurotech.com

Before returning any Eurotech product, for any reason, you must e-mail the Eurotech Technical Support Team on the above email address, giving the following information; you will then be sent an RMA number (Returned Material Authorization) for the return of the material:

- Model number (see Figure 1)
- Serial number (see Figure 1)
- Detailed fault description
- Company Details
- Contact details

Transportation

When transporting the module for any reason it should be packed using anti-static material and placed in a sturdy box with enough packing material to adequately cushion it.

**Warning:**

Any product returned to Eurotech that is damaged due to inappropriate packaging will not be covered by the warranty!

Board labelling

On the external side of the ISA Bus connector, you will find several labels displaying the following:

- Batch Number
- Serial Number
- Model Number
- Hardware Revision

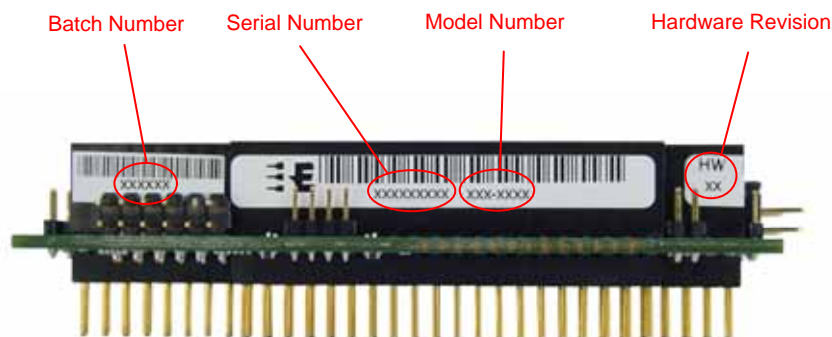

Figure 1. Board label locations

Table of Contents

Introduction	3
Conventions used within this Manual	3
<i>The “Mode” of the register:</i>	3
<i>Hexadecimal numbering:</i>	3
<i>Symbols and Text used in Pin-out tables:</i>	3
<i>Warnings and Important Notices:</i>	3
Technical Assistance	4
Transportation.....	4
Board labelling	4
Table of Contents	5
Chapter 1 Product Overview	7
Product Definition	8
<i>ACS-5161 PC/104 isolated power supply</i>	9
<i>60W DC/DC converter specifications</i>	9
<i>Application Areas</i>	9
Block Diagram	10
Electrical and Environmental Specifications.....	11
<i>Operating Characteristics</i>	11
<i>Absolute Maximum Ratings</i>	11
<i>MTBF</i>	11
Chapter 2 Jumper Description	13
Jumper Layout	13
Chapter 3 Connector Description	14
Connector Layout	14
How to connect the ACS-5161 to other PC/104 & PC/104-Plus devices.....	15
<i>The ISA Bus: J1 and J2</i>	15
<i>The stack assembly</i>	17
VIN: Isolated power supply input connector	18
External power connector	18
Output connector: +5V.....	19
Output connector: +12V	19
Chapter 4 Power Supply Description	21
Input protection and filtering	21
<i>Reverse voltage protection</i>	21
<i>Over voltage protection</i>	21
<i>Input filtering</i>	21
Isolated +5V DC/DC converter module	22
<i>Current Limiting</i>	23
<i>Remote On/Off control</i>	23
<i>+12V step up converter</i>	23
Status LED indicators	23
Appendix	25
A.1. Mechanical Dimensions.....	25

A.2. Manual Revision History26

Eurotech Group Worldwide presence27

Chapter 1 Product Overview

In the following paragraphs, you will find a brief description of the ACS-5161 characteristics.

The ACS-5161 is a galvanically isolated dual-output DC/DC power converter in a PC/104 form factor, it provides up to 100-Watts peak power (minimum 60 Watts continuous at extended temperature, if no structural heat sink is included). The ACS-5161 also features a special mechanical design hardened for extreme temperatures and high levels of shock and vibration, making it ideal for aircraft, rail, ship or industrial installations. All the components are securely fixed to the board for shock/vibration resistance.

For a complete list of our products visit our website: www.eurotech.com

Product Definition

Architecture

- PC/104 compliant

Isolation

- Galvanic Isolation

Voltage Input:

- +18 ~ 36 VDC Input range

Voltage Outputs:

- +5V, +12VDC

Power Output:

- 60 Watt Combined Output Power (-40°C through +85°C)
- 100W peak output power up to +70°C
- +5V @ 12A (20A peak)
- +12V @ 2.5A

Input Protection:

- Transient and reverse voltage protection (Input protected with automotive transient voltage suppressor, 6600W 10/1000us ideal for +24V battery installations)

Output Protection:

- 5V Overload Protected
- Over-temperature Shutdown

EMI Input Filter:

- Onboard input filter designed to comply with MIL-STD-461, CE, and EN-55022 class B conducted and radiated emissions

Other Features:

- LED Status Indicators
- Remote Shutdown Capability

Power Connectors:

- PC/104 Bus
- Screw Clamp Terminal Blocks
- HDD Terminal Block

RoHS:

- Fully RoHS (2002/95/CE) Compliant; RoHS replacement for ACS-5160

ACS-5161 PC/104 isolated power supply

- PC/104 form factor: 90x96mm, height: 27mm, DC/DC converter mounts below the board
- -40 to +85°C environmental operating temperature range, 100°C base plate temperature (max)
- Over-temperature shutdown of board and system when base plate temperature reaches 105°C
- Wide input range +18 to +36V DC (40V Absolute maximum short-term over-voltage)
- Transient voltage margin 50V for 100ms non repetitive
- Input protected with high speed transient voltage suppressor
- Outputs: +5V, and +12V, overload protection
- Power outputs without de-rating: +5V/12A, +12V/2A
- Peak output power +5V/20A, +12V/2.0A with limited operating temperature up to +70°C
- Low and high frequency filtering of inputs and outputs
- Meets requirements of EC low voltage directives for CE compliance

60W DC/DC converter specifications

- 100W peak output power
- 18-36V DC input range
- High efficiency, 88% typical
- 100us transient response 50-100% step
- 230kHz Fixed frequency operation
- 100°C base plate temperature
- Continuous short-circuit protection
- Remote shutdown (SHDN-jumper on the board)
- Thermal shutdown
- Isolation input-to output and input to base-plate 1500V
- Isolation output to base-plate 500V
- Operating temperature (case) -40 to +100°C, storage -55 to 125°C
- Shutdown temperature +105°C (base plate temperature)
- Thermal impedance 7.1°C/W

Application Areas

- High reliability systems
- Vehicle and mobile computers
- Industrial controllers
- Ship and airborne systems

Block Diagram

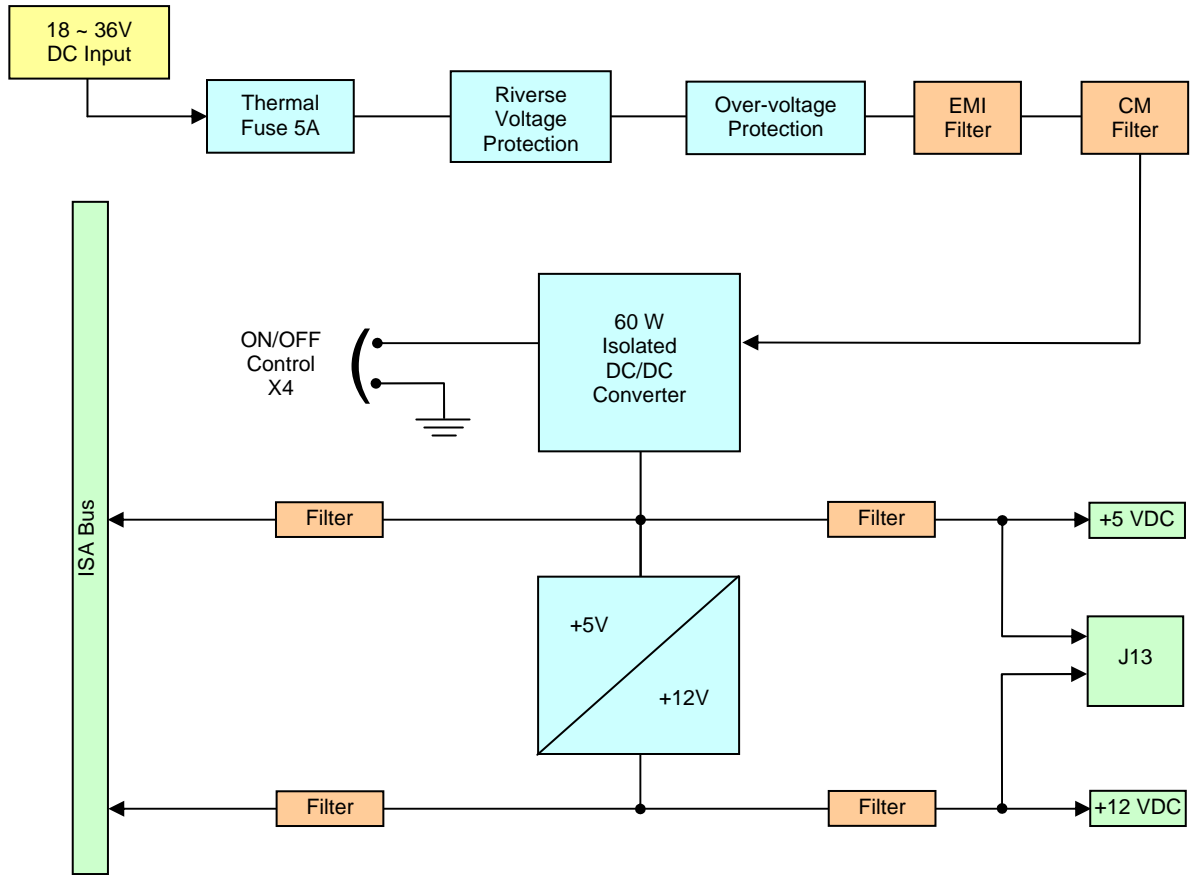

Figure 2. Functional block diagram of the ACS-5161 vehicle class power supply

Electrical and Environmental Specifications

Operating Characteristics

Electrical Operating Characteristics

Parameter	Nominal [VDC]	Minimum [VDC]	Maximum [VDC]
Voltage Output	+5.0	-	-
	+12.0	-	-
Voltage Input	+24.0	+18.0	+36.0*
Power output	<ul style="list-style-type: none"> Power outputs without de-rating: +5V/12A, +12V/2A Peak output power +5V/20A, +12V/2.0A with limited operating temperature up to +70°C 		

*High transient voltage margin (50V 1ms)

Operating Temperature Range

For correct operation of the module, the ambient air temperature must remain within the following range:

Standard	Minimum	-40 °C
	Maximum	+85 °C

Absolute Maximum Ratings

Supply Voltage	Minimum	18.0 V
	Maximum	40.0 V
Storage Temperature Range	Minimum	-45 °C
	Maximum	+85 °C
Non-Condensing Relative Humidity	<95% at 40°C	

Warning:



Stressing the module beyond the “Absolute Maximum Ratings” may cause permanent damage. These are stress ratings only. Operation beyond the “Operating Conditions” is not recommended. Extended exposure beyond the “Operating Conditions” may affect device reliability

MTBF

Hours	997,079 Hours (Ground Benign, Controlled GB, GC) 157,971 Hours (Airborne Inhabit Fighter, AIF)
Standard	MIL-HDBK-217F @ 40°C

(This page is intentionally left blank.)

Chapter 2 Jumper Description

Jumper Layout

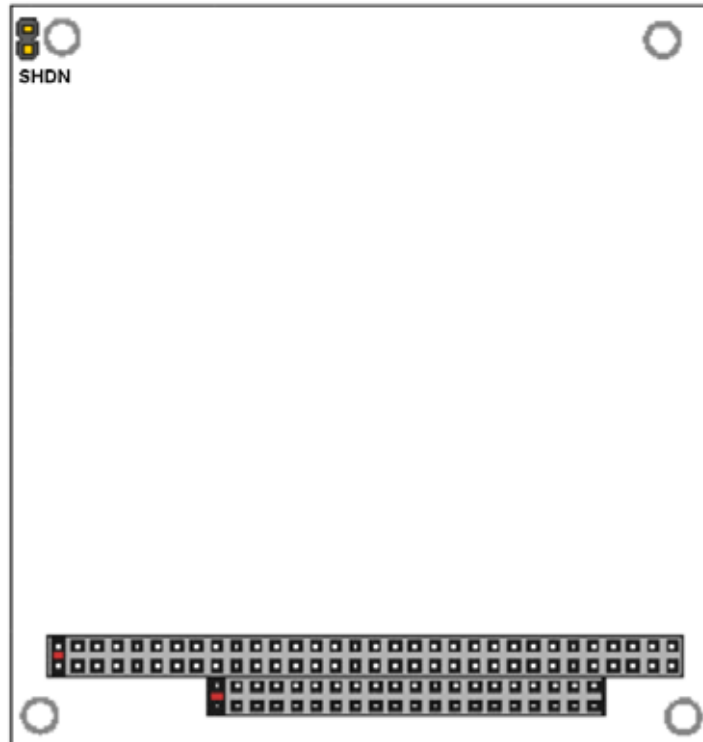

Figure 3. Jumpers and solder jumpers

Label	Function	Type	Options	Factory Default
/SHDN	Shutdown Control	2pin jumper	Closed: Turns off the complete power supply Open: Power supply module fully operational	Open

Table 1. Jumper Functions

Chapter 3 Connector Description

Connector Layout

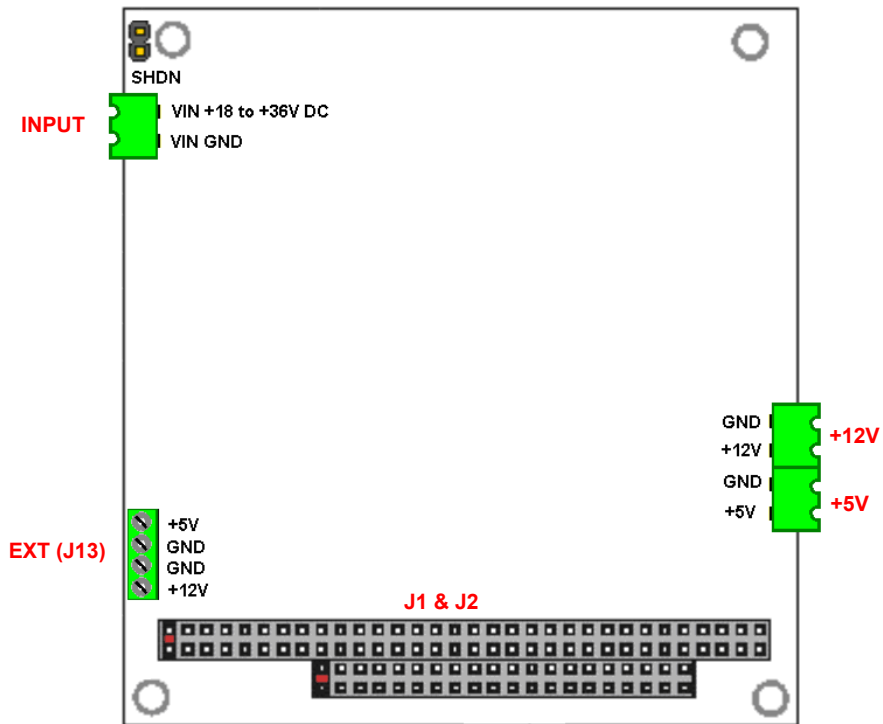

Figure 4. Connector layout

Connector	Function
J1 & J2	ISA BUS (PC/XT)
INPUT	+ 18 to +36V DC input
+5V	+5V screw terminal plug
+12V	+12V screw terminal plug
EXT (J13)	+5V and +12V output

Table 2. Connector functions

How to connect the ACS-5161 to other PC/104 & PC/104-Plus devices

The ISA Bus: J1 and J2

Connectors J1 and J2 carry the signals for the ISA Bus.
 These signals match the definitions of the IEEE P996 standard.

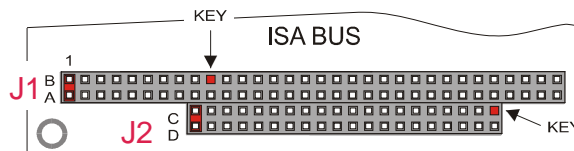

Figure 5. ISA BUS layout

According to the PC/104 specifications, these connectors include KEY pins; these are filled holes in the upper side and missing pins in the lower side of the bus. This is done to avoid the wrong insertion in/of another module.

Pin #	Use	Signal	Pin #	Use	Signal
1	ISA Bus	IOCHK#	33	ISA Bus	A14
2	ISA Bus	Ground	34	ISA Bus	DACK1#
3	ISA Bus	D7	35	ISA Bus	A13
4	ISA Bus	RSTDRV	36	ISA Bus	DRQ1
5	ISA Bus	D6	37	ISA Bus	A12
6	ISA Bus	+5 Volts	38	ISA Bus	REFRESH#
7	ISA Bus	D5	39	ISA Bus	A11
8	ISA Bus	IRQ 9	40	ISA Bus	ISACKL
9	ISA Bus	D4	41	ISA Bus	A10
10	ISA Bus	-5 Volts	42	ISA Bus	IRQ 7
11	ISA Bus	D3	43	ISA Bus	A9
12	ISA Bus	DRQ2	44	ISA Bus	IRQ 6
13	ISA Bus	D2	45	ISA Bus	A8
14	ISA Bus	-12 Volts	46	ISA Bus	IRQ 5
15	ISA Bus	D1	47	ISA Bus	A7
16	ISA Bus	ZEROWS#	48	ISA Bus	IRQ 4
17	ISA Bus	D0	49	ISA Bus	A6
18	ISA Bus	+12 Volts	50	ISA Bus	IRQ 3
19	ISA Bus	IOCHRDY	51	ISA Bus	A5
20	Not Connected	Key	52	ISA Bus	DACK2#
21	ISA Bus	AEN	53	ISA Bus	A4
22	ISA Bus	SMEMW#	54	ISA Bus	TC
23	ISA Bus	A19	55	ISA Bus	A3
24	ISA Bus	SMEMR#	56	ISA Bus	BALE

Pin #	Use	Signal
25	ISA Bus	A18
26	ISA Bus	IOW#
27	ISA Bus	A17
28	ISA Bus	IOR#
29	ISA Bus	A16
30	ISA Bus	DACK3#
31	ISA Bus	A15
32	ISA Bus	DRQ3

Pin #	Use	Signal
57	ISA Bus	A2
58	ISA Bus	+5 Volts –1
59	ISA Bus	A1
60	ISA Bus	OSC
61	ISA Bus	A0
62	ISA Bus	Ground 1
63	ISA Bus	Ground 3
64	ISA Bus	Ground 2

Table 3. J1 pinout

Pin #	Use	Signal
1	ISA Bus	Ground 0
2	ISA Bus	Ground 1
3	ISA Bus	SBHE#
4	ISA Bus	ISA_MEMCS16#
5	ISA Bus	LA23
6	ISA Bus	IOC16#
7	ISA Bus	LA22
8	ISA Bus	IRQ10
9	ISA Bus	LA21
10	ISA Bus	IRQ11
11	ISA Bus	LA20
12	ISA Bus	IRQ12
13	ISA Bus	LS19
14	ISA Bus	IRQ15
15	ISA Bus	LA18
16	ISA Bus	IRQ14
17	ISA Bus	LA17
18	ISA Bus	DACK0#
19	ISA Bus	MEMR#
20	ISA Bus	DRQ0

Pin #	Use	Signal
21	ISA Bus	MEMW#
22	ISA Bus	DACK5#
23	ISA Bus	SD8
24	ISA Bus	DRQ5
25	ISA Bus	SD9
26	ISA Bus	DACK6#
27	ISA Bus	SD10
28	ISA Bus	DRQ6
29	ISA Bus	SD11
30	ISA Bus	DACK7#
31	ISA Bus	SD12
32	ISA Bus	DRQ7
33	ISA Bus	SD13
34	ISA Bus	+5 Volts
35	ISA Bus	SD14
36	ISA Bus	MASTER#
37	ISA Bus	SD15
38	ISA Bus	Ground 2
39	ISA Bus	Not Connected
40	ISA Bus	Ground 3

Table 4. J2 pinout



Note:

For further information regarding the ISA and PCI bus, please visit the Eurotech website (<http://www.eurotech.com/>), referring to the section titled “Industry Standards.”

The stack assembly

The ISA and PCI bus connectors of the module are designed to allow it to be connected with other PC/104 and/or PC/104-Plus devices, we recommend users to follow this procedure to ensure that stacked modules are not damaged.



Warning:

Appropriate ESD (Electro Static Discharge) precautions should be used for the following procedure.

1. Turn off the power to the PC/104 (or PC/104-Plus) system or stack.
2. Select and install standoffs as required to correctly position the module on the PC/104 stack.
3. Remove the module from its anti-static bag.
4. Check that keying pins in the bus connector are correctly positioned.
5. Check the stacking order; make sure an XT bus card will not be placed between two AT bus cards or it will interrupt the AT bus signals.
6. Hold the module by its edges and orient it so that the bus connector pins line up with the matching connector on the stack.
7. Press the module evenly onto the PC/104 stack.

Figure 6 shows a typical module stack with two PC/104 modules, one PC/104 16-BIT module, and one PC/104 8-BIT module.

The maximum number of modules is four in addition to the Host Board.

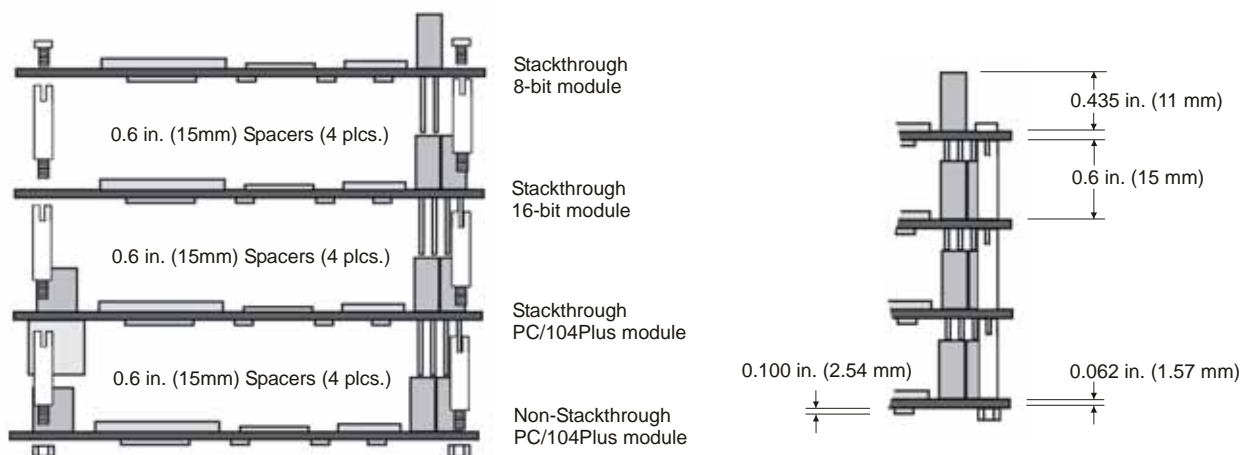

Figure 6. The Module Stack



Warning:

Do not force the module onto the stack! Wiggling the module or applying too much pressure may damage it. If the module does not readily press into place, remove it, check for bent pins or out-of-place keying pins, and try again.

VIN: Isolated power supply input connector

Use:

+18 to +36V DC Isolated Input

Description:

The ACS-5161 accepts a wide input voltage range from +18V to +36V DC. The absolute maximum input voltage is +40VDC. This makes this power supply ideal for nominal +24 to +28V installations requiring compliance with EN50155. The input is reverse voltage protected up to 45V. Transient protection diodes as well as a self-recovering 5A thermal fuse are used to protect the input of the power supply. Low radiated and conducted emissions are achieved by a purpose built common mode input filter and high frequency RF filter. The input will withstand over voltages of 50V for up to 100ms. As the input power of the module can reach 110-Watts, it is important to ensure that suitable input cables are used.

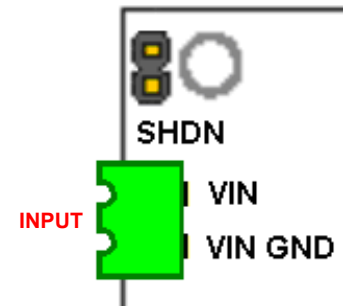

Note:

Note that the ground of this input power source is not connected to the computer ground. If the power input is below +18V, the power supply will not start.

External power connector

Use:

External Power Output

Description:

The external power output connector has two ground pins in the middle and additionally +5V and +12V. Use this screw terminal block to connect to your standard peripheral devices such as HDD and CD-ROM drives. Since J13 is rated at 6A, no more than 6A at 5V should be drawn through this connector.

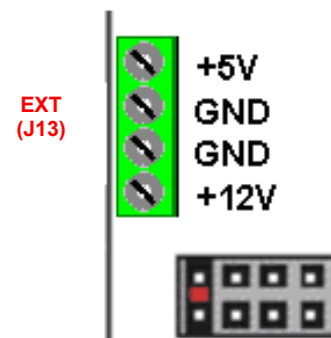

Warning:

Power terminals are connected in parallel with the equivalent outputs described above.

Output connector: +5V

Use:

+5 Volt Output

Description:

A 5 Volt 100-Watt output using an isolated switching DC/DC converter is used to power your complete 5V system. This converter feeds power into the PC/104 bus pins and is available for peripheral device connection on the locking screw terminal block as shown in the picture below. The +5V is filtered to reduce radiated noise on the output. The maximum output current of the +5V converter is 20A. The power consumption of the cascaded +12V converters must be taken into consideration while performing power calculations. The current rating on the +12V converter is 12A maximum. Even though the power supply can provide up to 20A, only 12A maximum should be run through J3.

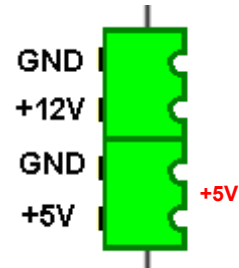

Output connector: +12V

Use:

+12 Volt Output

Description:

The +12 Volts 25-Watt output uses a highly efficient switching DC/DC converter to create the +12V from +5V. This converter feeds power into the PC/104 bus pins and is available for peripheral device connection on the locking screw terminal block as shown in the picture below. The +12V is filtered to reduce radiate noise on the output. The maximum output current of the +12V output is 2.0A. The output is over current protected and will withstand a permanent short circuit condition. The maximum peak transient current supply is 3A.

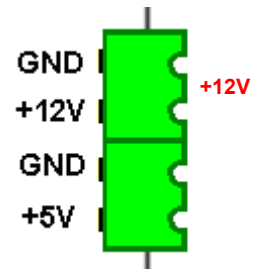

(This page is intentionally left blank.)

Chapter 4 Power Supply Description

Input protection and filtering

Reverse voltage protection

Input power reversal is a common error condition in power supply connection or installation in hostile electrical environments. The ACS-5161 power supply will withstand reverse voltages up to 45V indefinitely. A series Schottky diode on the positive supply input line also protects the transient absorber diodes from forward conducting in a reverse voltage condition. The reverse voltage protection diode is rated for a 9.0A input current.

Over voltage protection

A high-speed 1500-Watt transient absorber diode will clip all input transients below acceptable limits. The series input filters will also reduce the incoming energy of the over voltage pulse. The ACS-5161 will tolerate a short-term over voltage condition up to 50V for a period of 100ms and a long term over voltage up to 40VDC. A thermal fuse mounted on the solder side of the board rated at 5A is connected in series with the input. The normal maximum input current to the power supply is 4.5A assuming the input power is 80W. The thermal fuse will blow if the over voltage protection diodes start conducting, or if the power supply module is approaching its thermal operating limits. The thermal fuse is self-recovering and the power supply will work normally after the error condition is removed.

Input filtering

Low radiated and conducted emissions are important when selecting power supplies for professional embedded systems. All the power outputs from the onboard DC/DC converter subsystems are filtered using power ferrites reducing emissions in the frequency range of 30 to 150MHz. The ACS-5161 will exceed the requirements of the EC low voltage directives for CE compliance. An input filter specially dimensioned for the ACS-5161 power supply ensures compatibility with EN-55022 class B or MIL-STD-461 requirements for conducted and radiated emissions.

The frame of the converter (as well as the chassis if it is conductive) may be connected to the ground of the power supply output. This is the configuration by default. You may need to change this depending on the grounding scheme of your complete system. Places on the board are reserved for filter coupling capacitors (C27 and C26) for coupling the +5V and the computer ground to the chassis. If you wish to capacitively couple power supply ground to the chassis ground, disconnect the factory set solder blob FRAME GND to remove the galvanic connection of ground from the chassis ground.

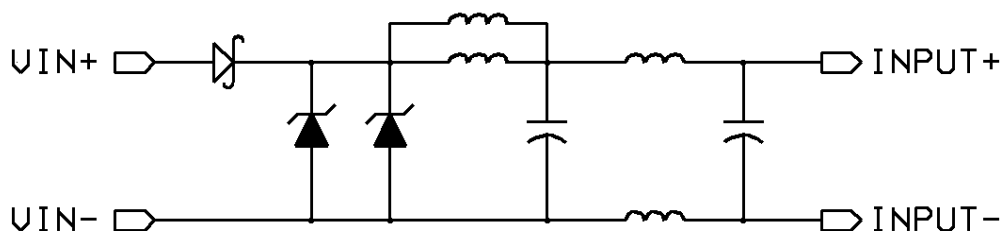

Figure 7. Input filter of the ACS-5161

Isolated +5V DC/DC converter module

The main +5V output is designed based on a monolithic extended temperature range galvanically isolated 100-Watt DC-DC converter module. The converter output current is internally limited to 20A. This Eurotech converter design is unique offering an easy solution for structural heat sinking of the power supply. The filtering and shielding of the DC/DC converter ensures low input ripple current and low radiated noise under all load conditions. Use of optimal PCB layout and use of low ESR OSCON capacitors ensure un-degraded performance over the complete operating temperature range of -40 to +85C. Mounting the ACS-5161 on a heat conducting base plate for structural heat sinking is easy as the DC/DC converter module is mounted on the bottom side of the power supply. The power supply is intended to be the bottom-most board in your PC/104 stack.

The input of this converter is protected to meet the requirements of automotive, airborne and vessel installations. Fast transient absorber diodes, a thermal fuse and a low loss 9A forward biased Schottky diode are necessary to protect the input in 12/24V automotive and industrial installations against fast over voltage spikes and reverse voltage transients. The ASC-5161 will tolerate voltage spikes up to 50V for up to 100ms.

The main +5V converter supplies the PC/104 +5V bus with power. This power is available for external devices from an external terminal block. (See previous section for the location of terminal block.)

Characteristic	Minimum	Typical	Maximum	Units	Notes
Power		100		W	
Output Current		20		A	
Output Setpoint Voltage	4.92	5.00	5.08	Vdc	Vin=24V, Io=20A
Line Regulation		0.02	0.20	%Vo	Vin=18 to 36V, Io=20A
Load Regulation		0.1	0.5	%Vo	Io=0 to 20A, Vin=24V
Dynamic Response					
50 to 75% Load		1.5		%Vo	Ta=25 °C, di/dt=1A/10us
		100		us	Ta=25 °C, di/dt=1A/10us
50 to 25% Load		1.5		%Vo	Ta=25 °C, di/dt=1A/10us
		100		us	Ta=25 °C, di/dt=1A/10us
Current Limit Threshold	22.0	24.5	28.0	A	
Short Circuit Current		30		A	
Efficiency	86	88		%	Vin=24V, Io=20A
Temperature Regulation			0.02	%Vo/°C	
Ripple (rms)		20	40	mV	(0 to 20MHz Bandwidth)
Noise (pk-pk)		100	150	mV	(0 to 20MHz Bandwidth)
Over Temperature Protection		105		°C	

Table 5. 5V DC/DC converter specifications

Current Limiting

To protect the ACS-5161 against fault or error conditions the +5V DC/DC converter circuit is equipped with current limiting to provide continuous overload protection. After reaching the current limit point (typically 5 - 10% exceeding the rated maximum current), the output voltage will vary between the rated nominal output and zero depending on the level of overload. Once the short circuit condition is removed, the output will return to the nominal value without restarting the power supply or switching power off.

Remote On/Off control

The header connector labelled X1 near the input terminal block of the board is the remote ON/OFF control. Closing this contact will disengage the ACS-5161 and place the converter in standby condition. In this condition, the ACS-5161 will still consume some power. This control signal could be connected to the ignition key of an automobile, vehicle or machine.

+12V step up converter

A high efficiency step-up DC/DC converters with high efficiency generates the +12V volts for peripheral devices such as EL- or TFT- panels, hard drives, motors etc. The +12V output can supply up to 3.0A peak current (2.0A continuous -40 to +85°C). The high-level peak current will ensure that the converter can respond to short-term currents. +12V supply is available from terminal block and the 4-position screw terminal block near the bus connector. The +12V supply also powers the PC/104 bus power pins. The +12V power outputs are filtered with ferrites to reduce the radiated emitted from the board.

Status LED indicators

Two green status LED indicators near the right hand side of the board give the state of the power outputs. The LED indicators are connected to the +5V and +12V outputs.

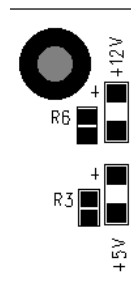
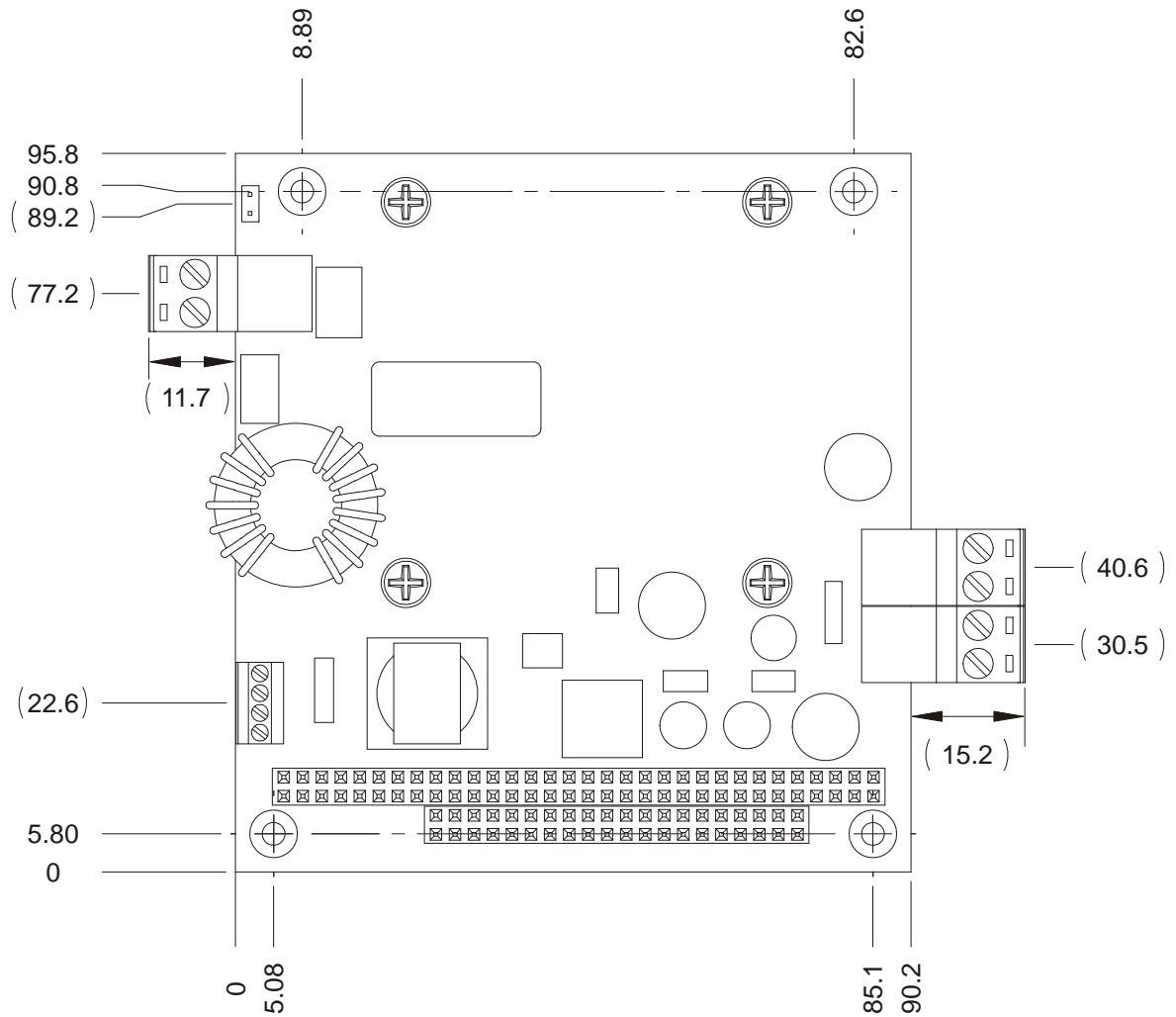

Figure 8. Status LED locations

(This page is intentionally left blank.)

Appendix

A.1. Mechanical Dimensions



Dimensions are in millimetres

Figure 9. ACS-5161 Board dimensions



Note:

For further information about the mechanical dimensions of ISA and PCI buses please refer to the PC/104 consortium site (www.pc104.org)

A.2. Manual Revision History

REVISION	DESCRIPTION	DATE
1.0	First Release	November 2008

Eurotech Group Worldwide presence

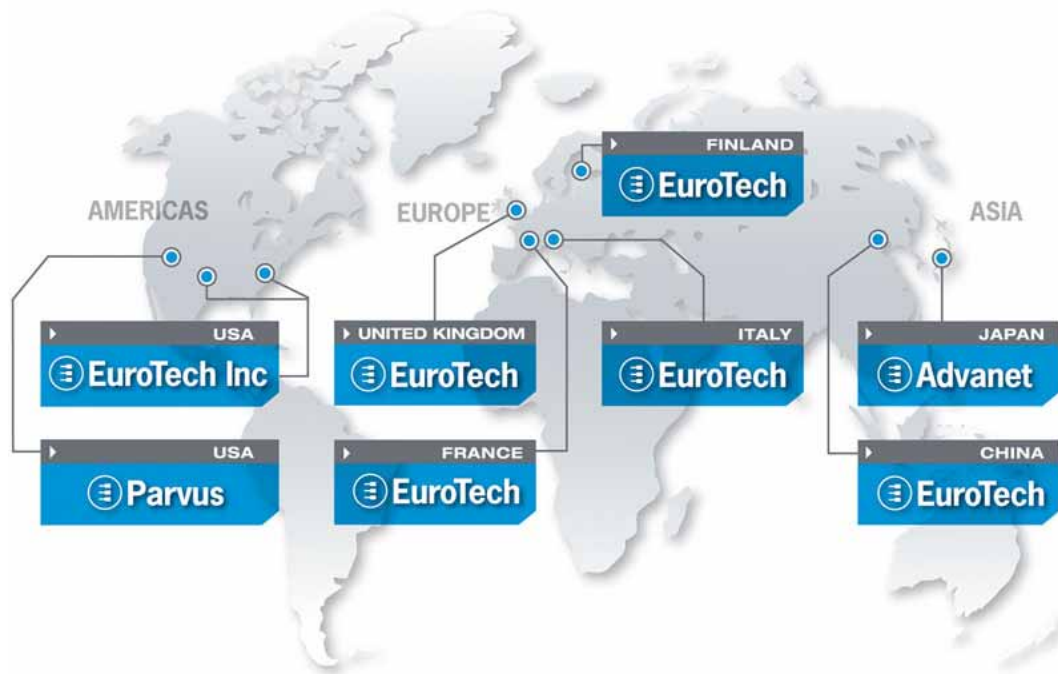

AMERICAS

EUROPE

ASIA



North America

EUROTECH Inc
 toll free +1 888.941.2224
 tel. +1 301.490.4007
 fax +1 301.490.4582
 e-mail: sales-us@eurotech.com
 e-mail: support-us@eurotech.com
 www.eurotech-inc.com

PARVUS CORPORATION
 tel. +1 800.483.3152
 fax +1 801.483.1523
 e-mail: sales@parvus.com
 e-mail: tsupport@parvus.com
 www.parvus.com

Central & Southern Europe

EUROTECH Italy
 tel. +39 0433.485.411
 fax +39 0433.485.499
 e-mail: sales-it@eurotech.com
 e-mail: support-it@eurotech.com
 www.eurotech.com

Western Europe

EUROTECH UK
 tel. +44 (0) 1223.403410
 fax +44 (0) 1223.410457
 e-mail: sales-uk@eurotech.com
 e-mail: support-uk@eurotech.com
 www.eurotech.com

EUROTECH France
 tel. +33 04.72.89.00.90
 fax +33 04.78.70.08.24
 e-mail: sales-fr@eurotech.com
 e-mail: support-fr@eurotech.com
 www.eurotech.com

Northern & Eastern Europe

EUROTECH Finland
 tel. +358 9.477.888.0
 fax +358 9.477.888.99
 e-mail: sales-fi@eurotech.com
 e-mail: support-fi@eurotech.com
 www.eurotech.com

ADVANET Japan
 tel. +81 86.245.2861
 fax +81 86.245.2860
 e-mail: sales@advanet.co.jp
 www.advanet.co.jp

EUROTECH China
 tel. +86 10.62.67.09.04
 fax +86 10.62.67.09.54
 e-mail: sales-cn@eurotech.com
 e-mail: support-cn@eurotech.com
 www.eurotech.com



